



DAUD JEE Mfg.Co

Micro Instruments



Daud Jee Mfg.Co.
Nishat Park, Paris Road.
Sialkot-1. Pakistan

info@daudjeemfg.com
Tel: +92-52-4270818
Fax: +92-52-4270616



Daud Jee Mfg. Co



Ratched



Multi Lock



Counterbalance



Streamline



Extra Light



Safety Pin



Diamond Dusted



Master Light

INHALT CONTENT

Micro Needle Holder	DNH / DNHB	06
Ring Needle Holder	DNH / DNHB	15
Micro Forceps	DGF / DGFB	16
Forceps	DGF / DGFB	20
Micro Scissors	DSC / DSCB	24
Scissors / Scissors TITANIT	DSC / DSCB	29
Clamps	DGL / DKF	47
Micro-Bulldog Clamps	DGF	50
Special Instruments		51
Disposable Products	DDSP	55
Index		58



Daud Jee Mfg.Co



Features and Benefits of titanium Blue-Line Instruments

LIGHT WEIGHT

- 45% lighter than stainless steel instruments.
- enables tireless working for the surgeon for long operations under the microscope
- offers permanently high precision to the operating surgeon and may therefore reduce traumatization of delicate vessels and arteries

ANTIMAGNETIC

Titanium is an antimagnetic material. It avoids sticking of the needle holder to the stainless suture needles. This allows an optimal, secure and continuous working.

NO RUST - LONG LIFE

Titanium material and instruments do not rust. You will never have problems with rust.

MAINTENANCE / CLEANING

Titanium instruments are principally very easy to clean and maintain. Titanium instruments may be cleaned with usual detergent for surgical instrument. Please rinse the instrument after use. Therefore we recommend especially for all Micro instrument and Diamond knives our steam cleaner unit item no. ST 9000. On request we offer you cleaning fluid for the instrument too. Before sterilisation we recommend to oil the surgical instrument with our „STERISOFT“ item no. OL 5000.





Daud Jee Mfg. Co



Vorteile und Nutzen
Features and Benefits

DAUDJEE TITANIUM NEEDLEHOLDER WITH MULTI-LOCK SYSTEM MICRO NEEDLE HOLDER-ONE FOR TWO



DAUDJEE Multi - Lock needle holder can be used with lock or without lock. The removable lock allows a surgeon intraoperative changing of the lock system. For example when the nurse handles the suture with the closed lock, the surgeon can remove the lock during operation easily. Or one surgeon likes to work with lock and the other one without lock. DAUDJEE Multi-Lock System gives you these opportunities. No-lock problems with an easy and secure closing mechanism.

DIAMOND DUSTED

Finest metallurgically bonded particles create a fine atraumatic surface for extremely atraumatic handling of tissues and suture.

For example: -diamond dusted forceps are optimal for fine atraumatic fixation of tissue, micro vessels and fine delicate suture for knitting.
- diamond dusted DAUDJEE microneedle holders allow you to use suture up to most delicate suture.



Daud Jee Mfg. Co



Micro Needle Holder, Titanium

with Multi Lock



	curved 6-0 >	straight 5-0 >
125mm, 5"	DNH 8981	DNH 8030

straight
8-0 >

curved
8-0 >

straight
6-0 >

curved
6-0 >

140mm, 5 1/2"	DNH 8900	DNH 8901	DNH 8006	DNH 8005
145mm, 5 3/4"				

with Multi Lock





Daud Jee Mfg. Co



Micro Needle Holder, Titanium

EXTRA LIGHT



curved

without ratched
12x0,4 mm
7-0 >



140mm, 5 1/2 "	DNH 8060
160mm, 6 1/4 "	DNH 8064
210mm, 8 1/4 "	DNH 8066

	curved without ratched 7-0 >	straight with ratched 7-0 >	straight with ratched 5-0 >	curved with ratched 5-0 >
140mm, 5 1/2 "	DNH 8411			
165mm, 6 1/2 "		DNHB 8529 S	DNHB 8527 S	DNHB 8927 S





Daud Jee Mfg. Co



Micro Needle Holder, Titanium

	straight with Multi Lock 0,4x11 mm 7-0 >	straight with Multi Lock 0,4x10 mm 8-0 >	straight without ratched 0,4x11 mm 7-0 >	straight with Multi Lock 0,4x11 mm 7-0 >
185 mm, 7"			DNH 8310	
205 mm, 8"	DNH 8016-1	DNH 8349	DNH 8348	DNH 8016-2
230 mm, 9"		DNH 8028		

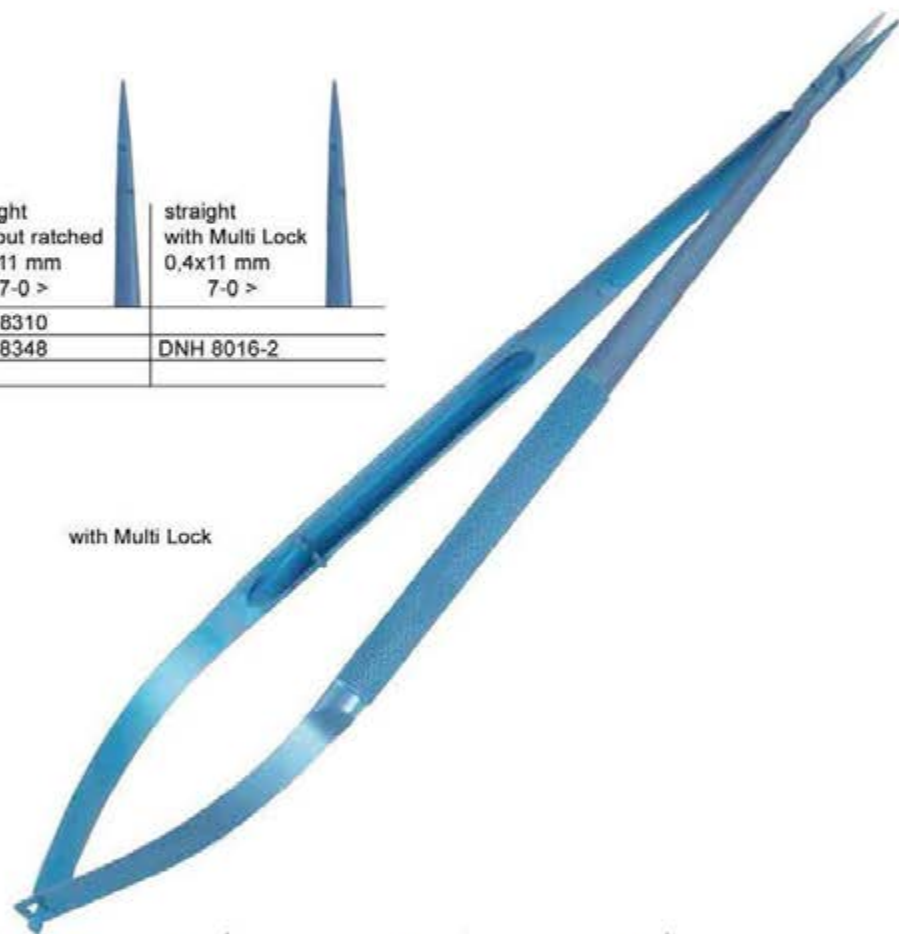

DELICATE

	straight with Multi Lock 0,8x12 mm 6-0 >	curved with Multi Lock 0,8x12 mm 6-0 >	straight with Multi Lock 1,6x12 mm 5-0 >	straight with Multi Lock 2,0x14 mm 3-0 >	straight without Lock 0,8x11 mm 6-0 >	straight with ratched 0,8x11 mm 6-0 >
160 mm, 6 1/4"	DNH 8008	DNH 8009				
185 mm, 7 1/4"	DNH 8010	DNH 8011			DNH 8012	DNH 8010F
205 mm, 8"	DNH 8016	DNH 8017	DNH 8070	DNH 8026		DNH 8016F
230 mm, 9"	DNH 8018	DNH 8019	DNH 8118			DNH 8018F
250 mm, 10"	DNH 8020	DNH 8021	DNH 8022			DNH 8020F
300 mm, 12"						DNH 8074 (5-0>)



Daud Jee Mfg. Co



Micro Needle Holder, Titanium

	straight with Multi Lock 6-0 >	curved with Multi Lock 6-0 >	curved without ratched 6-0 >
185 mm, 7"	DNH 8098	DNH 8099	
210 mm, 8 1/4"		DNH 8100	DNH 8108
250 mm, 10"	DNH 8102	DNH 8104	

ELEGANCE

for off pump surgery more compression allows optimal needle fixation

curved 6-0 > bis/to 8-0 >	working length	
245 mm, 9 1/2"	125 mm, 4 3/4"	DMN 0583T

BAJO

with Multi Lock

working length

with ratched

	straight with ratched 0,4x12 mm 7-0 >	straight with ratched 0,6x12 mm 5-0 >	straight without ratched 0,4x12 mm 7-0 >	straight without ratched 0,8x12 mm 6-0 >
160 mm, 6"			DMD 8079	
185 mm, 7"	DMD 8834	DMD 8070-1		DMD 8014
215 mm, 8 1/4"	DMD 8835	DMD 8070-2	DMD 8835-1	
230 mm, 9"	DMD 8520	DMD 8070-3		

FLANT HANDLE



Daud Jee Mfg. Co



	straight with ratched 3-0 >	curved with ratched 3-0 >	straight without ratched 3-0 >
190 mm, 7 1/2"	DNHB 8141S	DNHB 8741S	DNHB 8141
230 mm, 9"	DNHB 8191S		DNHB 8191
250 mm, 10"	DNHB 9194S		DNHB 9194S

TIGER



with pin Lock

	curved Pin Lock 6-0 >	straight Pin Lock 6-0 >
215 mm, 8 1/4"	DNH 8040	DNH 8040

PEN

Micro Needle Holder, Titanium



Heavy modell

with ratched



Daud Jee Mfg. Co



Micro Steel Needle Holder



straight
Multi Lock
6-0 >

160 mm, 6 1/4" DNH 3010

MICRO



MICRO-DELICATE
curved
mit Sperre with ratched
8-0 >

180 mm, 7" DNHB 5119

MICRO-DELICATE

with Multi Lock

with ratched



with ratched

with ratched

glatt smooth straight 7-0 >

glatt smooth curved 7-0 >

Diamont Dusted straight 5-0 >

Diamont Dusted curved 5-0 >

150 mm, 6"	DMN 1300	DMN 1300		
185 mm, 7"	DMN 1346D	DMN 1347D		DMN 0078
210 mm, 8 1/4"	DMN 1348D	DMN 1349D		
230 mm, 9"	DMN 1352	DMN 1353	DMN 1354D	DMN 1355D
230 mm, 9"	DMN 1352D	DMN 1353D		
without ratched	glatt smooth straight 7-0 >	glatt smooth curved 7-0 >	glatt smooth straight 5-0 >	glatt smooth curved 5-0 >
185 mm, 7"	DMN 1320	DMN 1330	DMN 1332	DMN 1333
	DMN 1320D	DMN 1330D	DMN 1332D	DMN 1333D
210 mm, 8 1/4"	DMN 1342	DMN 1343	DMN 1334	DMN 1335
	DMN 1342D	DMN 1343D	DMN 1334D	DMN 1335D
250 mm, 10"			DMN 1338	DMN 1339
			DMN 1338D	DMN 1339D

MICRO



Daud Jee Mfg. Co



Micro Steel Needle Holder

	MICRO SLIM LINE 8-0 >	MICRO SLIM LINE 7-0 >	SLIM LINE 5-0 >	MEDIUM LINE 5-0 >	MAKRO LINE TIGER 5-0 >
150 mm, 6"		DNHB 5127S	DNHB 5125S		
150 mm, 6"		DNHB 5127	DNHB 5125		
180 mm, 7"	DNHB 5148S	DNHB 5147S	DNHB 5145S		
180 mm, 7"	DNHB 5148	DNHB 5147	DNHB 5145		
190 mm, 7 1/2"		DNHB 5357S	DNHB 5354S		DNHB 5141S
190 mm, 7 1/2"		DNHB 5357	DNHB 5354		DNHB 5141
205 mm, 8"	DNHB 5158S	DNHB 5157S	DNHB 5155S		
205 mm, 8"	DNHB 5158	DNHB 5157	DNHB 5155		
230 mm, 9"	DNHB 5188S	DNHB 5187S	DNHB 5185S		DNHB 5191S
230 mm, 9"	DNHB 5188	DNHB 5187	DNHB 5185		DNHB 5191
230 mm, 9" (curved)		DNHB 5287S			
250 mm, 10"	DNHB 5198S	DNHB 5197S	DNHB 5195S		DNHB 5194S
250 mm, 10"	DNHB 5198	DNHB 5197	DNHB 5195		DNHB 5194





Daud Jee Mfg. Co



with ratched		smooth standard straight 6-0 >	STEEL smooth straight 6-0 >
200 mm, 8"		DMD 0835	DMD 0835T

ERGONOMY

Micro Steel Needle Holder

with cutting edge for suture







serrated tip with ratched		straight with cutting edge 6-0 >		curved with cutting edge 6-0 >
180 mm, 7"		DNH 0094		DNH 0095

KOMBI

Diamond Dust tip



	curved without ratched 7-0 >		curved without ratched 7-0 >		curved without ratched 7-0 >		curved without ratched 7-0 >		curved without ratched 7-0 >
210 mm, 8 1/4"	DNHB 7088S	DNHB 7089S	DNHB 7088	DNHB 7089					

MICRO-CARDIO



Daud Jee Mfg. Co



Castroviejo Micro Steel Needle Holder

Diamond Dust

	with ratched straight 7-0 >	without ratched straight 7-0 >
145 mm, 5 3/4"	DNHB 4515S	DNHB 4515
180 mm, 7"	DNHB 4525S	DNHB 4525
205 mm, 8"	DNHB 4535S	DNHB 4535
230 mm, 9"	DNHB 4545S	DNHB 4545

TOPAS

smooth tip POWER-TC

	with ratched straight 5-0 >	without ratched straight 5-0 >
145 mm, 5 3/4"	DNHB 4715S	DNHB 4715
180 mm, 7"	DNHB 4725S	DNHB 4725
205 mm, 8"	DNHB 4735S	DNHB 4735
230 mm, 9"	DNHB 4745S	DNHB 4745

TOPAS

serrated tip POWER-TC

	with ratched straight 5-0 >	with ratched curved 5-0 >	with ratched straight 5-0 >
145 mm, 5 3/4"	DNHB 4815S	DNHB 4915S	
180 mm, 7"	DNHB 4825S	DNHB 4925S	
205 mm, 8"	DNHB 4835S	DNHB 4935S	DNHB 4834S
230 mm, 9"	DNHB 4845S	DNHB 4945S	

TOPAS





Daud Jee Mfg. Co



Ringneedle Holder, Titanium and steel

Valve Needle Holder
Stahl steel

3-0 >

180 mm, 7"

DNHB 1004

STRONG CURVED



Micro Needle Holder

6-0 >

150 mm, 6"

DNH 6000

180 mm, 7"

DNH 6001

205 mm, 8"

DNH 6002

230 mm, 9"

DNH 6003

EUPHRATE-PASQUE



Titanium
Diamond Dust

6-0 >

125 mm, 5"

DNH 8802

145 mm, 5 3/4"

DNH 8804

175 mm, 7"

DNH 8806

195 mm, 7 3/4"

DNH 8808

225 mm, 8 3/4"

DNH 8810

MICRO- STEEL

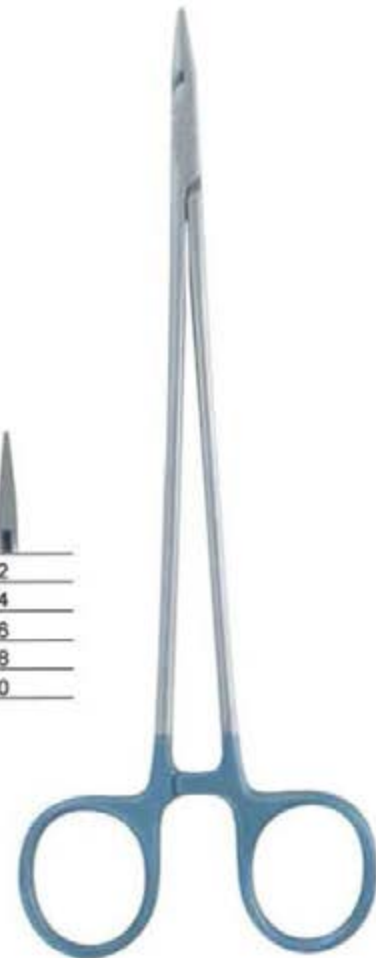

Steel
Diamond Dust

5-0 >

MICRO
6-0 >

130 mm, 5"

DNH 6015

152 mm, 6"

DNH 6016

175 mm, 7"

DNH 6018

DNH 6028

220 mm, 8 3/4"

DNH 6022

DNH 6030

300 mm, 12"

DNH 6025

DNH 6033

ELEGANCE



Daud Jee Mfg. Co



Micro Forceps, Titanium

	1 mm	4 mm	counterbalance gerade straight	light weight gerade straight	counterbalance gebogen curved
160 mm, 6 1/4"	4 mm	DGF 8019	DGF 8119		
160 mm, 6 1/4"	1 mm	DGF 8020	DGF 8120	DGF 8071	
180 mm, 7"	1 mm	DGF 8021	DGF 8121	DGF 8025	
210 mm, 8 1/2"	1 mm	DGF 8023	DGF 8123		
230 mm, 9"	1 mm	DGF 8024			
250 mm, 10"	1 mm	DGF 8029			

DE BAKEY

	with delicate Plateau	straight Gegengew. counterbalance	straight ohne Gegengew. light weight	straight Gegengew. light weight delicate	curved Gegengew. counterbalance	curved Gegengew. light weight	strong 2 mm Gegengew. counterbalance
145 mm, 5 3/4"		DGF 8044					
160 mm, 6 1/4"		DGF 8046	DGF 8146		DGF 8047	DGF 8147	
180 mm, 7"		DGF 8048	DGF 8148		DGF 8049	DGF 8149	
210 mm, 8 1/2"		DGF 8050	DGF 8150	DGF 8060	DGF 8051	DGF 8151	DGF 8080
230 mm, 9"			DGF 8152				
250 mm, 10"			DGF 8154				

PLATEAU

	with ring	Small 0,6 x 1,2 Gegengew. counterbalance with plateau	Delicate 1,9 x 0,4 Gegengew. light waight with plateau	Small 1,6 x 1,2 Gegengew. light waight without plateau	Small 1,6 x 1,2 Gegengew. light waight with plateau	Medium 1,2 x 1,8 Gegengew. counterbalance	Medium 1,2 x 1,8 Gegengew. light weight
150 mm, 6"		DGF 8002			DGF 8102	DGF 8003	DGF 8103
160 mm, 6 1/4"		DGF 8004			DGF 8104	DGF 8005	DGF 8105
180 mm, 7"		DGF 8001	DGF 8030	DGF 8101-1	DGF 8101	DGF 8000	DGF 8100
210 mm, 8 1/2"		DGF 8010			DGF 8110	DGF 8011	DGF 8111
230 mm, 9"		DGF 8012			DGF 8112	DGF 8016	
250 mm, 10"		DGF 8013			DGF 8113	DGF 8018	

RINGTIP



Daud Jee Mfg. Co



MikroTying Forceps,

without Plateau

straight

115 mm, 4 1/2"	DGF 8502
185 mm, 7"	DGF 8148-1
210 mm, 8 1/2"	DGF 8150-1
230 mm, 9"	DGF 8152-1
250 mm, 10"	DGF 8154-1

SMOOTH

mit Ring
withring

gerade
straight

185 mm, 7"	DGF 8014
210 mm, 8 1/2"	DGF 8015

**ELEGANCE
SURE GRIP**

for off pump surgery more
compression allows optimal
indications



straight
counterbalance

straight
light weight

0.3x0.7

with Micro-Ringtip
counterbalance

150 mm, 6"	DGF 8026	DGF 8036	
160 mm, 6 1/2"		DGF 8035	
185 mm, 7 1/4"	DGF 8027	DGF 8037	
210 mm, 9 1/4"	DGF 8028	DGF 8038	DGF 8009

COMBI-SPECIAL

Suture and Tying Forceps



Daud Jee Mfg. Co



Mikro Titanium Forceps



with Ring

200 mm, 7"

WAHL

1,2 x 1,8 mm	
Bajonett shaped, curved with round handle	
	DPZ 8005



for soft tissue



straight

210 mm, 8,25"	DGF 8890
240 mm, 9 1/2"	DGF 8892

ANATOMIC





with plateau

180 mm, 7"

MICRO DELICATE

	DGF 8031
--	----------

De Bakey Atraumatic straight

straight

straight

185 mm, 7"	DGF 8189	DGF 8017
210 mm, 8 1/4"	DGF 8190	DGF 8196

GERALD



Daud Jee Mfg. Co



Mikro Titanium Forceps

fein fine
bajonette shape
0,7 mm

straight
1,1 mm

220 mm, 8 3/4"

DMN 8660

DMN 8661

straight

150 mm, 6"

DGF 8175

190 mm, 7 1/2"

DGF 8170

MC INDOE

1 x 2 Zahne
gerade
1 x 2 teeth
straight

0,6 mm
Maul tip

1,0 mm
Maul tip

1,5 mm
Maul tip

150 mm, 6"

DMN 8085

DMN 8086

160 mm, 6"

DMN 8087 (Flachgriff/ flat handle)

210 mm, 8 1/4"

DMN 8058

LINZ

with Counter Balance



Daud Jee Mfg. Co



Mikro Steel Forceps



	Flat tip Diamond Dust tip gerade straight	De Bakey tip atraumatic gerade straight	Ring tip Diamond Dust tip gerade straight
185 mm, 7"	DGFB 4318	DGFB 4518	DGFB 4418
210 mm, 8 1/4"	DGFB 4321	DGFB 4521	DGFB 4421
230 mm, 9"	DGFB 4323	DGFB 4523	DGFB 4423

GERALD



Needle Pulling Forceps POWER-TC	1,5 mm Breite width	2,0 mm Breite width	2,7 mm Breite width	3,5 mm Breite width
180 mm, 6 1/4"	DPZ 0416	DPZ 0426	DPZ 0436	DPZ 0446
200 mm, 7"	DPZ 0417	DPZ 0427	DPZ 0437	DPZ 0447
240 mm, 9"	DPZ 0418	DPZ 0428	DPZ 0438	DPZ 0448



Mikro Forceps Steel



**with ring 1,0 x 0,5mm
without plateau**

	with counterbalance straight	with counterbalance curved	light weight straight
150 mm, 6"	DGFB 5315	DGFB 5315-1	DGFB 5115
180 mm, 7"	DGFB 5318	DGFB 5318-1	DGFB 5118
210 mm, 8 1/2"	DGFB 5321	DGFB 5321-1	DGFB 5121
230 mm, 9"	DGFB 5323	DGFB 5323-1	DGFB 5123
250 mm, 10"	DGFB 5325	DGFB 5325-1	DGFB 5125

RINGTIP

with delicate plateau

	with counterbalance straight	with counterbalance curved	light weight straight
150 mm, 6"	DGFB 6215	DGFB 6215-1	DGFB 6315
180 mm, 7"	DGFB 6218	DGFB 6218-1	DGFB 6318
210 mm, 8 1/2"	DGFB 6221	DGFB 6221-1	DGFB 6321
230 mm, 9"	DGFB 6223	DGFB 6223-1	DGFB 6323
250 mm, 10"	DGFB 6225	DGFB 6225-1	DGFB 6325

PLATEAU

	with counterbalance	light weight
180 mm, 7"	DGFB 5518	DGFB 6518
210 mm, 8 1/2"	DGFB 5521	DGFB 6521
230 mm, 9"	DGFB 5523	DGFB 6523
250 mm, 10"	DGFB 5525	DGFB 6525

DE BAKY



Daud Jee Mfg. Co



Atraum. Titanium Tissue and Vasc Forceps



length	wide	straight	25° angled
150 mm, 6"	1,2 mm	DGF 8090	
180 mm, 7"	1,2 mm	DGF 8091	
200 mm, 8 3/2"	1,5 mm	DGF 8092	
220 mm, 8"	1,2 mm	DGF 8092-1	
240 mm, 9 1/2"	1,5 mm	DGF 8093	
300 mm, 12"	1,5 mm	DGF 8095	DGF 8098



DE BAKKEY



Daud Jee Mfg. Co



Atraumatic Titanium Tissue and Vascular Forceps



straight length	wide	order no.
150 mm, 6"	1.0 mm	DGF 8739
	1.5 mm	DGF 8730
	2.0 mm	DGF 8740
	2.9 mm	DGF 8790
155 mm, 6"	2.5 mm	DGF 8778
185 mm, 7"	1.5 mm	DGF 8832
	2.5 mm	DGF 8780
	3.5 mm	DGF 8800
200 mm, 8"	1.0 mm	DGF 8820
	2.0 mm	DGF 8760
	2.9 mm	DGF 8791
	3.5 mm	DGF 8800
210 mm, 8 1/4"	2.5 mm	DGF 8781
240 mm, 9 1/2"	1.0 mm	DGF 8824
	1.5 mm	DGF 8835
	2.5 mm	DGF 8782
	2.9 mm	DGF 8792
	3.5 mm	DGF 8810
	4.0 mm	DGF 8794
300 mm, 12"	2.0 mm	DGF 8763
	2.9 mm	DGF 8793
	4.0 mm	DGF 8794

DE BAKERY

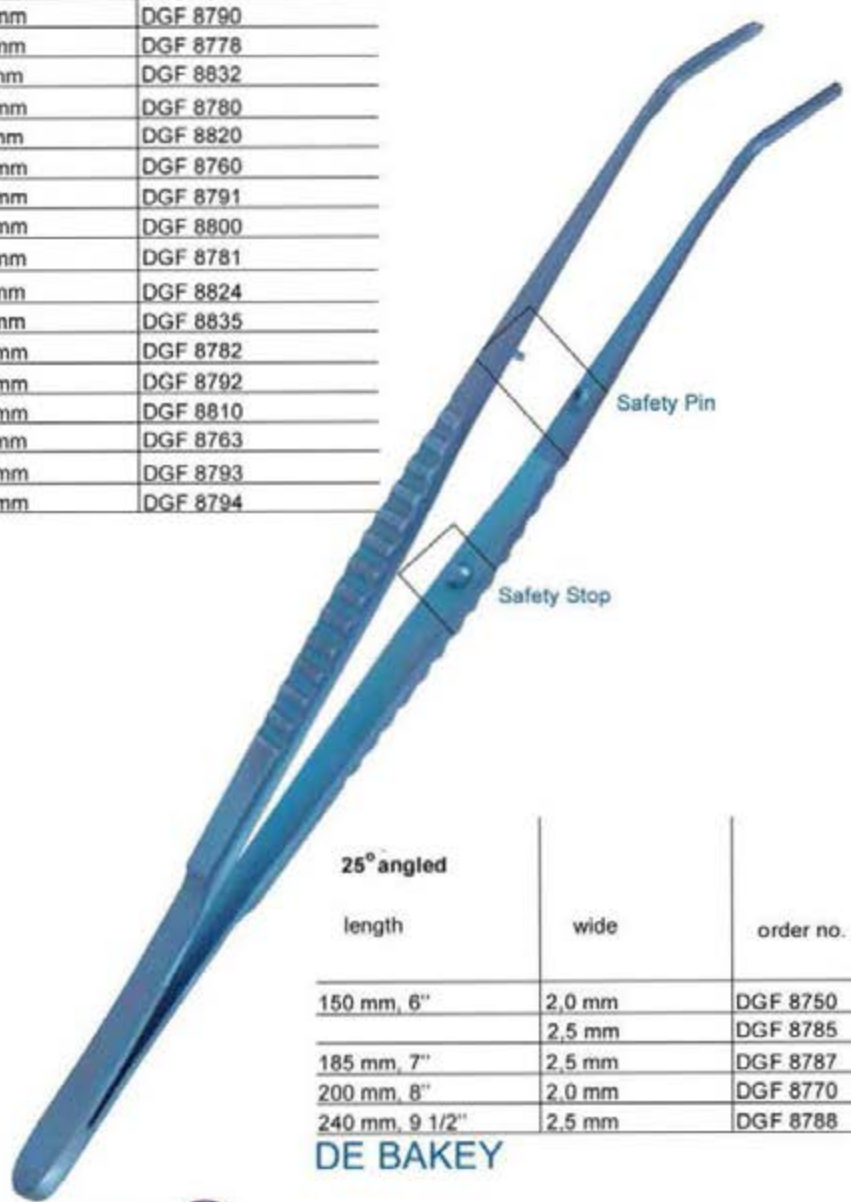

25° angled length	wide	order no.
150 mm, 6"	2.0 mm	DGF 8750
	2.5 mm	DGF 8785
185 mm, 7"	2.5 mm	DGF 8787
200 mm, 8"	2.0 mm	DGF 8770
240 mm, 9 1/2"	2.5 mm	DGF 8788

DE BAKERY



Daud Jee Mfg. Co



Micro Steel Scissors

micro scissors with flat handle	curved	25°	45°	60°	90°	125° Cirkumflex	125° eng narrow Cirkumflex	180° for off pump surgery
standard line 165mm, 6 1/2"	DSC 0031	DSC 0032	DSC 0033	DSC 0034	DSC 0035	DSC 0036	DSC 0038	DSC 0037
long line 200mm, 8"		DSC 0173	DSC 0174	DSC 0175	DSC 0176	DSC 0177-1	DSC 0177	DSC 0178

Kugelschutz safety bead tip with safety ball tip for downer vascular wall

165mm, 6 1/2"	DSC -0134	DSC -0135	DSC -0136	DSC -0137	DSC -0138	DSC -0139	DSC -0141
200mm, 8"	DSC -0214	DSC -0215	DSC -0216	DSC -0217	DSC -0218	DSC -0219	DSC -0211

MICRO SWAN



mit Flachgriff
with flat handle

micro scissors with flat handle	straight	curved	25°	45°	60°	90°	125°	125° narrow	straight DELICATE
standard line 165mm, 6 1/2"	DSC 0004	DSC 0005	DSC 0006	DSC 0007	DSC 0008	DSC 0009	DSC 0010		DSC 0089
long line 200mm, 8"			DSC 0103	DSC 0104	DSC 0105	DSC 0106	DSC 0107	DSC 0101	

SLIM LINE SWAN

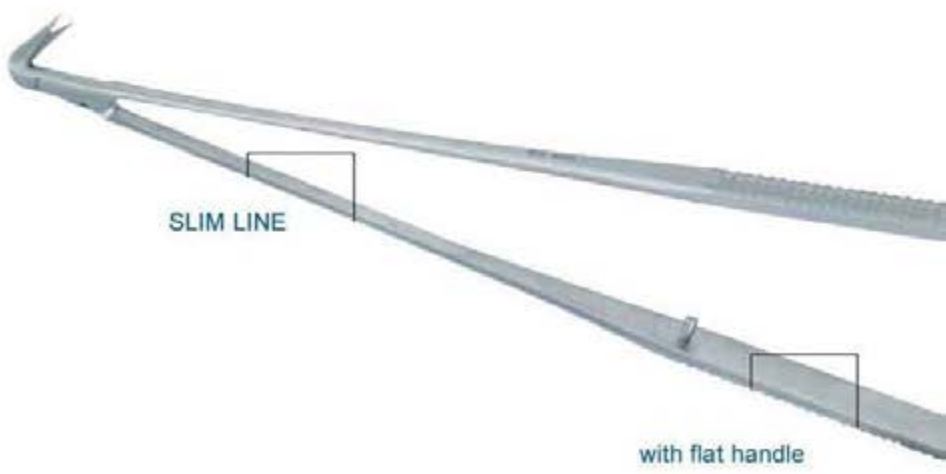

SLIM LINE

with flat handle



Daud Jee Mfg. Co



Micro Steel Scissors

micro scissors with round handle for off pump								
		25° curved	45°	60°	90°	125° Cirkumflex	125° eng narrow Cirkumflex	180° for off pump surgery
kurz short 110mm, 4 1/4"	DSC 0091	DSC 0092	DSC 0093	DSC 0094	DSC 0095	DSC 0096		
standard line 165mm, 6 1/2"	DSC 0041	DSC 0042	DSC 0043	DSC 0044	DSC 0045	DSC 0046	DSC 0048	DSC 0047
long line 200mm, 8"		DSC 0198	DSC 0199	DSC 0203	DSC 0204	DSC 0205		

Kugelschutz safety bead tip with safety ball tip for downer vascular wall								
	165mm, 6 1/2"	DSC 0144	DSC 0145	DSC 0146	DSC 0147	DSC 0148	DSC 0149	DSC 0151
	200mm, 8"	DSC 0224	DSC 0225	DSC 0226	DSC 0227	DSC 0228	DSC 0229	DSC 0221

MICRO SWAN

micro scissors with round handle						
	curved	25°	45°	60°	90°	125° Cirkumflex
standard line 165mm, 6 1/2"	DSC 0153	DSC 0154	DSC 0155	DSC 0156	DSC 0157	DSC 0158
extra long 250mm, 10"				DSC 0156-1		DSC 0158-1

SLIM LINE SWAN

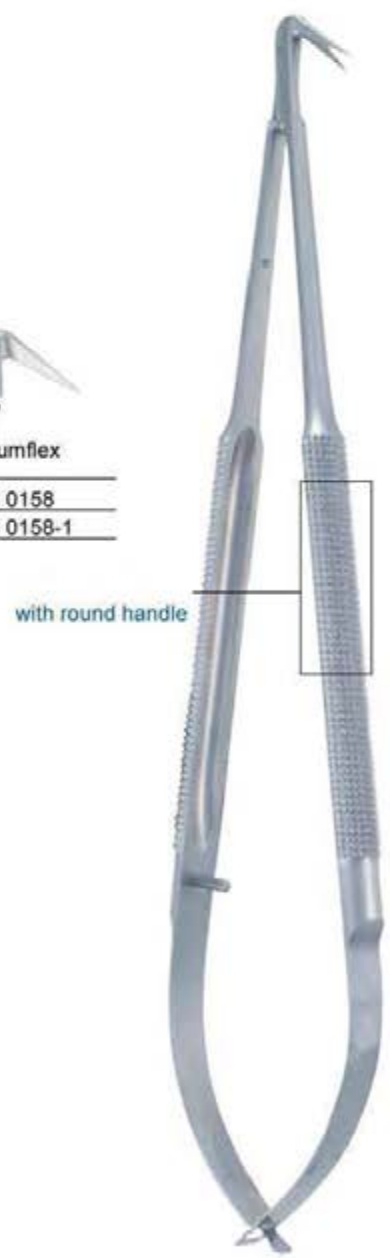











Daud Jee Mfg. Co



Micro STAINLESS STEEL Scissors









micro scissors with flat handle								
	curved	25°	45°	60°	90°	125° Cirkumflex	125° eng narrow Cirkumflex	180° for off pump surgery
standard line 165mm, 6 1/2"	DSC 0031T	DSC 0032T	DSC 0033T	DSC 0034T	DSC 0035T	DSC 0036T	DSC 0038T	DSC 0037T
long line 200mm, 8"		DSC 0173T	DSC 0174T	DSC 0175T	DSC 0176T		DSC 0177T	DSC 0178T

Kugelschutz safety bead tip with safety ball tip for downer vascular wall

	165mm, 6 1/2"	DG 8981	DG 8981	DG 8981	DG 8981	DG 8981	DG 8981	DG 8981
	200mm, 8"	DG 8981	DG 8981	DG 8981	DG 8981	DG 8981	DG 8981	DG 8981

MICRO SWAN



micro scissors with flat handle								
	curved	25°	45°	60°	90°	125°	125° eng narrow	gerade straight DELICATE
standard line 165mm, 6 1/2"	DSC 0005T	DSC 0006T	DSC 0007T	DSC 0008T	DSC 0009T	DSC 0010T		DSC 0089T
long line 200mm, 8"		DSC 0103T	DSC 0104T	DSC 0105T	DSC 0106T	DSC 0107T	DSC 0101T	

SLIM LINE SWAN







Daud Jee Mfg. Co



Micro STAINLESS STEEL Scissors

micro scissors with round handle for off pump									
	gebogen	25° curved	45°	60°	90°	125° Cirkumflex	125° eng narrow Cirkumflex	180° for off pump surgery	
	kurz short 110mm, 4 1/4"	DSC 0091T	DSC 0092T	DSC 0093T	DSC 0094T	DSC 0095T	DSC 0096T		
	standard line 165mm, 6 1/2"	DSC 0041T	DSC 0042T	DSC 0043T	DSC 0044T	DSC 0045T	DSC 0046T	DSC 0048T	DSC 0047T
long line 200mm, 8"		DSC 0198T	DSC 0199T	DSC 0203T	DSC 0204T		DSC 0205T	DSC 0221T	

Kugelschutz safety bead tip with safety ball tip for downer vascular wall

	165mm, 6 1/2"		DSC 0144T	DSC 0145T	DSC 0146T	DSC 0147T	DSC 0148T	DSC 0149T	DSC 0151T
	200mm, 8"		DSC 0224T	DSC 0225T	DSC 0226T	DSC 0227T	DSC 0228T	DSC 0229T	

MICRO SWAN

micro scissors with round handle							
	gebogen curved	25°	45°	60°	90°	125° Cirkumflex	
	standard line 165mm, 6 1/2"	DSC 0153T	DSC 0154T	DSC 0155T	DSC 0156T	DSC 0157T	DSC 0158T
	extra long 250mm, 10"				DSC 0156-1T		

SLIM LINE SWAN

with round handle



NEW! Long Line 200 mm



Micro Steel Scissors, bajonett

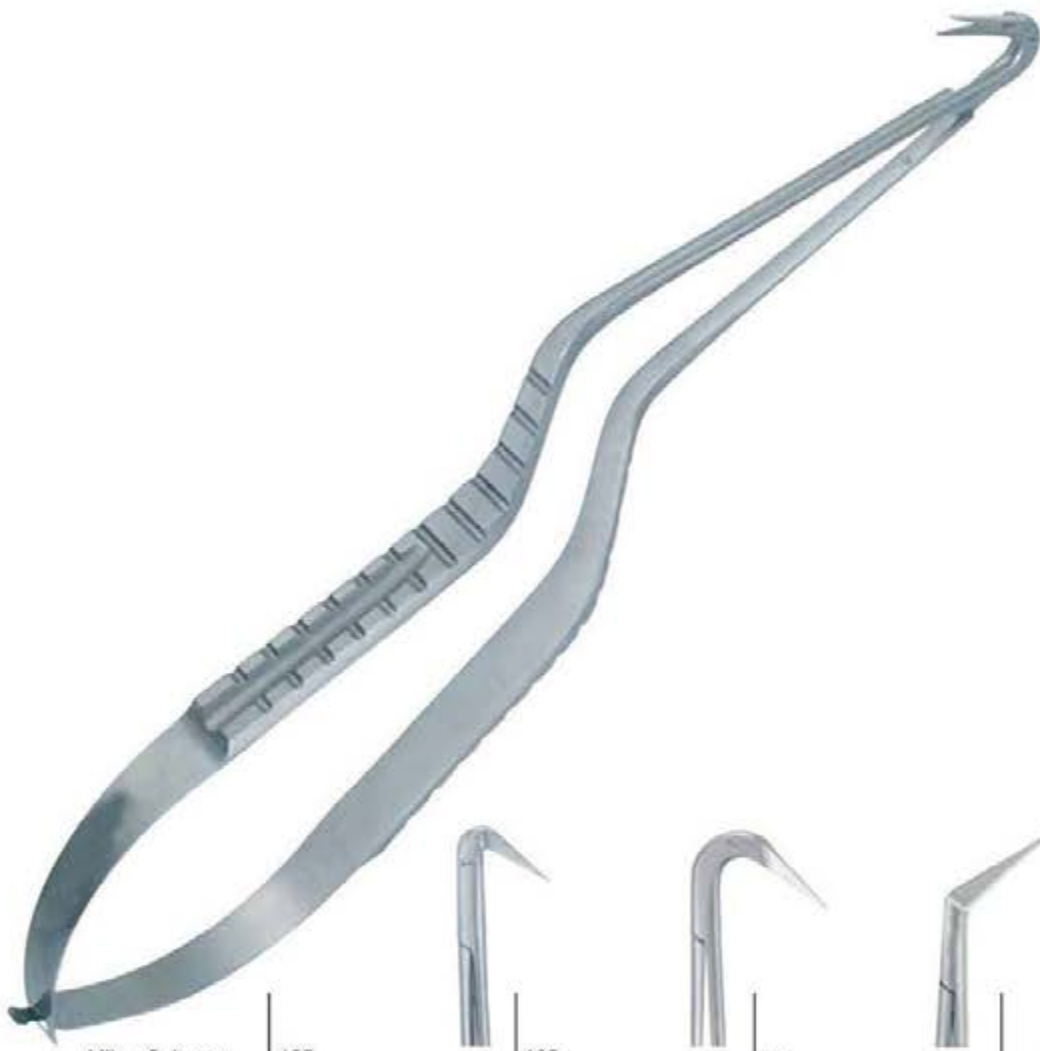

Mikro Scheren,
Bajonett
micro scissors,
bajonett shape

125
Cirkumflex



125
Cirkumflex



45
gewinkelt angled
curved upwards
tenotomy tips



Tenotomie Blatter
straight
tenotomy tips



Tenotomie Blatter



195 mm, 7 3/4"
200 mm, 8"
205 mm, 8"

DMN 0277 N

DMN 0277

DMN 0269

DMN 0279

DMN 0278





PEACOCK



Daud Jee Mfg. Co



Micro Scissors Delicate

					
curved	Kilner-Blatt blunt	tenotomy tips, blunt	Ragnell tips, sharp	fine round tips, sharp	
145 mm, 5 3/4"		DSC 1126			
180 mm, 7"	DSC 1135	DSC 1136	DSC 1137	DSC 1138	

GLASGOW

Delicate tip

plastic surgery

curved

120 mm, 4 3/4"	DSC 7650
150 mm, 6"	DSC 7651
180 mm, 7"	DSC 7656
200 mm, 8"	DSC 7658

KILNER

Delicate tip





Daud Jee Mfg. Co



Micro Ringhandle Scissors

		25°	45°	60°	90°	125°
130 mm, 5"	Steel	DSC 8821	DSC 8831	DSC 8841	DSC 8851	DSC 8861
170 mm, 6 3/4"	Steel	DSC 8822	DSC 8832	DSC 8842	DSC 8852	DSC 8862
170 mm, 6 3/4"	Steel			DSC 1842		

MICRO SLIM LINE POTTS

Steel	25°	45°	60°	90°	125°
170 mm, 6 3/4"	DSC 8764	DSC 8765	DSC 8767	DSC 8768	DSC 8769

SLIM LINE POTTS

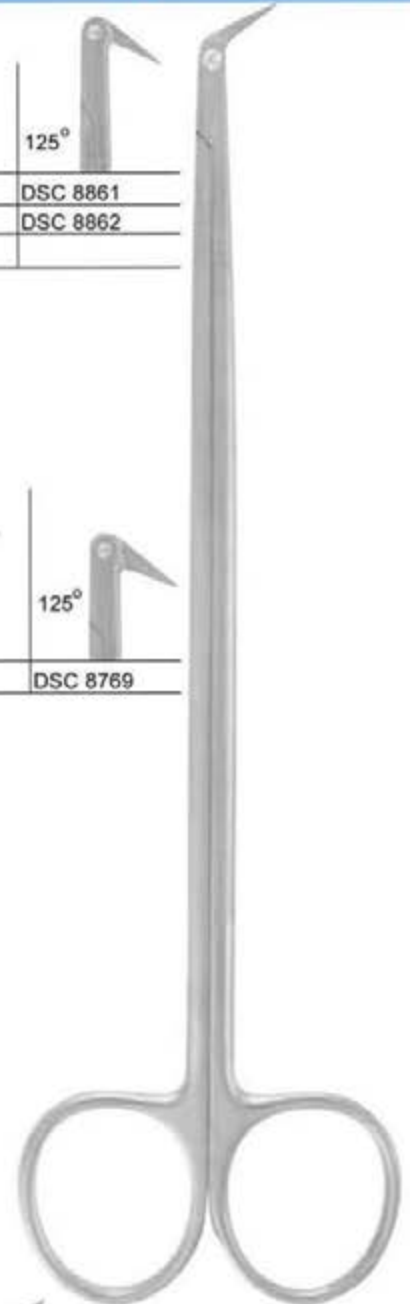
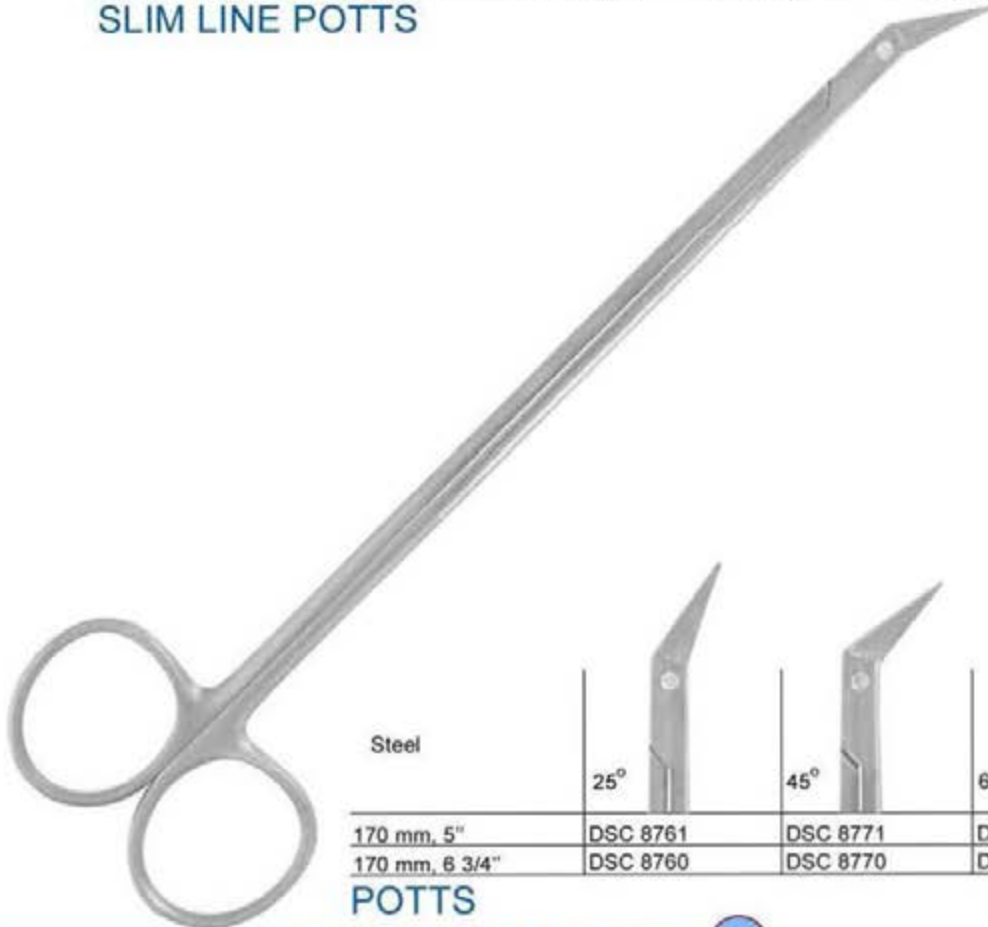

Steel	25°	45°	60°	90°	125°
170 mm, 5"	DSC 8761	DSC 8771	DSC 8781	DSC 8783	DSC 8785
170 mm, 6 3/4"	DSC 8760	DSC 8770	DSC 8780	DSC 8710	DSC 8711

POTTS



Daud Jee Mfg. Co



Ringhandle Scissors

				
	25°	45°	60°	90° with balltip
180 mm, 7"			DSC 8562	DSC 8691
185 mm, 7 1/4"		DSC 8561		
190 mm, 7 1/2"	DSC 8560			

POTTS-SMITH

neo intima scissor
fine flat blades
strongly curved

145 mm, 5 1/4"	DSC 2753
200 mm, 8"	DSC 2763

GOLF





Daud Jee Mfg. Co



Brilliant Scissors

specifically for „Recidive“	FINO Steel	Standard Steel	FINO TITANIT	Standard STAINLESS STEEL
180 mm, 7"	DSCB 7305		DSC 8150	
194 mm, 7 3/4"	DSCB 7007		DSCB 8007	
120 mm, 8 3/4"	DSCB 7009		DSCB 8009	
167 mm, 10 1/2"	DSCB 7013		DSCB 8013	
280 mm, 11"	DSCB 7015	DSCB 7025	DSCB 8015	DSCB 8025

POWER CUT

specifically for recidive indication





Daud Jee Mfg. Co



Fine STAINLESS STEEL Scissors

Augenschere
Ophthalmology

straight



curved



90 mm, 3 1/2"

DSC 8426

DSC 8427

BONN



Iris scissor

straight



curved



110 mm, 4 1/4"

DSC 8410

DSC 8411

IRIS



spitz sharp tips



curved
spitz sharp tips



straight
stumpf blunt tips



curved
stumpf blunt tips



115 mm, 4 1/2"

DSC 8438

DSC 8439

DSC 8436

DSC 8437

STEVENS



Daud Jee Mfg. Co

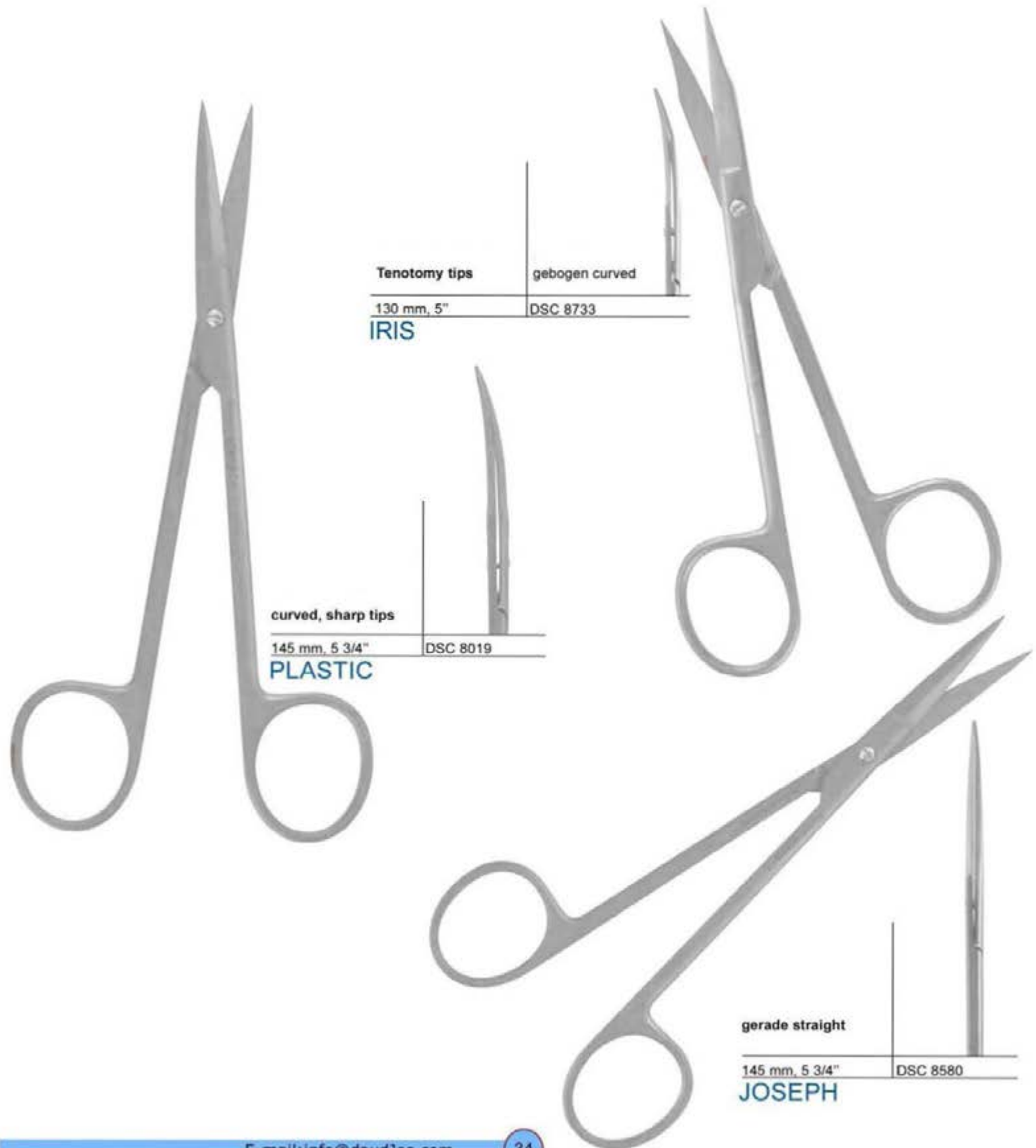

Tenotomy tips	gebogen curved
130 mm, 5"	DSC 8733

IRIS

curved, sharp tips	
145 mm, 5 3/4"	DSC 8019

PLASTIC

gerade straight	
145 mm, 5 3/4"	DSC 8580

JOSEPH



Daud Jee Mfg. Co



Delicate STAINLESS STEEL Scissors

Dissecting scissors with fine tenotomy blades

curved

135 mm, 5 1/2"

DSC 8712

JAMESON-WERBER

Dissecting scissors with fine tenotomy blades

curved

125 mm, 5"

DSC 8447

STEVENS

Dissecting scissors with fine tenotomy blades

curved

145 mm, 5 3/4"

DSC 8075

156 mm, 6 1/4"

DSC 8730

185 mm, 7"

DSC 8440

230 mm, 9"

DSC 8441

250 mm, 10"

DSC 8442

REYNOLDS

delicate dissecting scissors

stumpf/ stumpf
blunt tips
2,0 mm

spitz / spitz
sharp tips
1,0 mm

stumpf/ stumpf
blunt tips
2,5 mm

150 mm, 6"

DSC 8515

DSC 8002

DSC 8004

SALZBURG



Daud Jee Mfg. Co



Delicate STAINLESS STEEL Dissecting Scissors

finedissecting scissors

curved

150 mm, 6"

DSC 8626

SALZBURG



standard

curved

180 mm, 7"

DSC 8652

KILNER

fine tips
curved

150 mm, 6"

DSC 8651

180 mm, 7"

DSC 8731

200 mm, 8"

DSC 8653

230 mm, 9"

DSC 8654

250 mm, 9 3/4"

DSC 8655

RAGNELL-TUULA





Daud Jee Mfg. Co



STAINLESS STEEL Dissecting Scissors

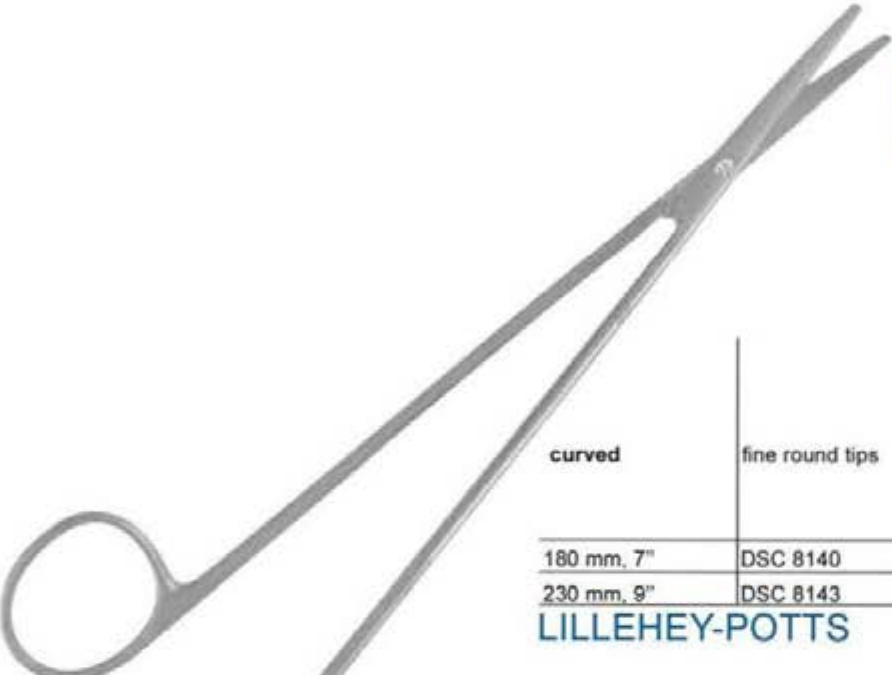

curved	fine round tips	fine sharp tips
180 mm, 7"	DSC 8140	DSC 8141
230 mm, 9"	DSC 8143	

LILLEHEY-POTTS



curved		round blades
180 mm, 7"	DSC 8150	DSC 8153
	DSC 8151	width tip)
280 mm, 11"	DSC 8145	

TOENNIS-ADSON

curved	straight
110 mm, 4 1/4"	DSC 8001
125 mm, 5"	DSC 8950

METZENBAUM MINI

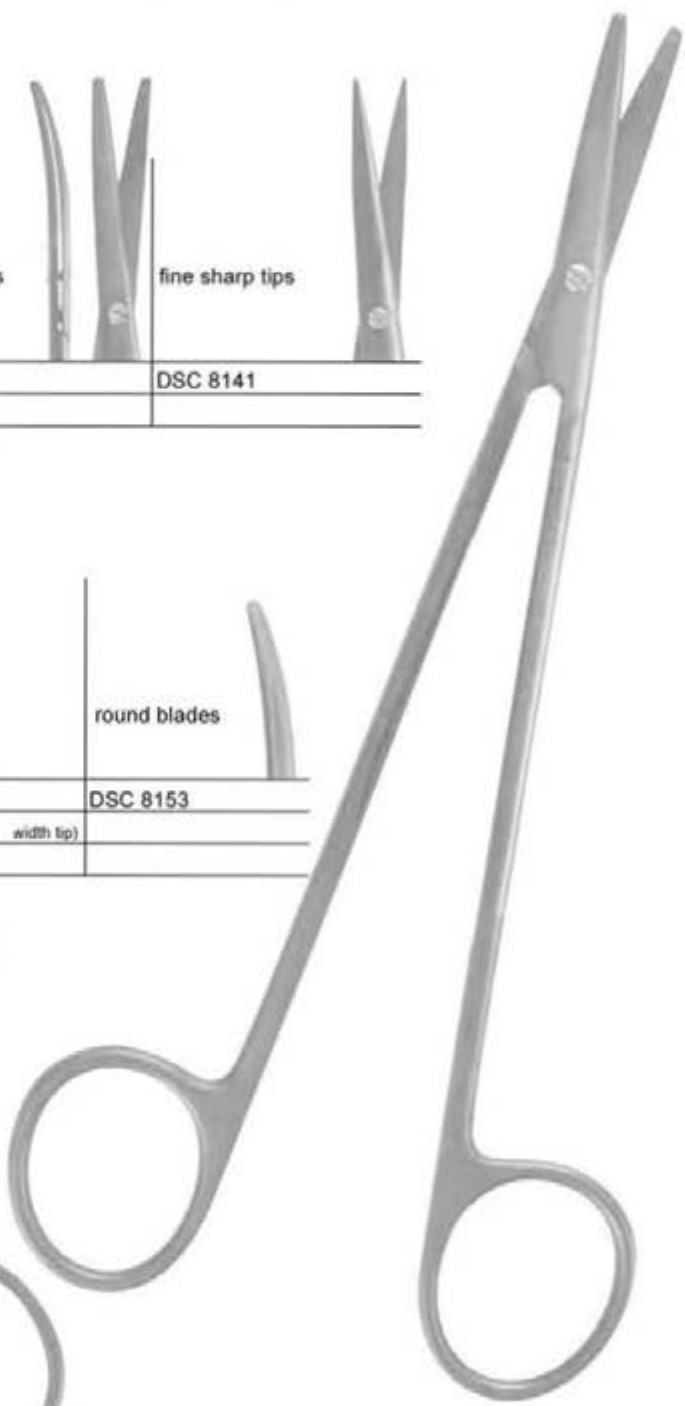
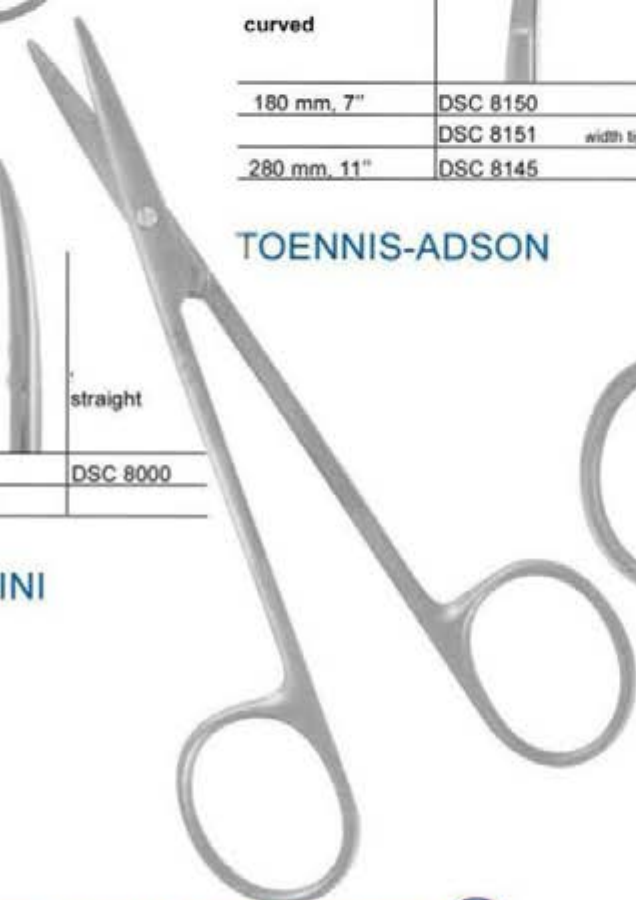



Daud Jee Mfg. Co



STAINLESS STEEL Metzenbaum Scissors

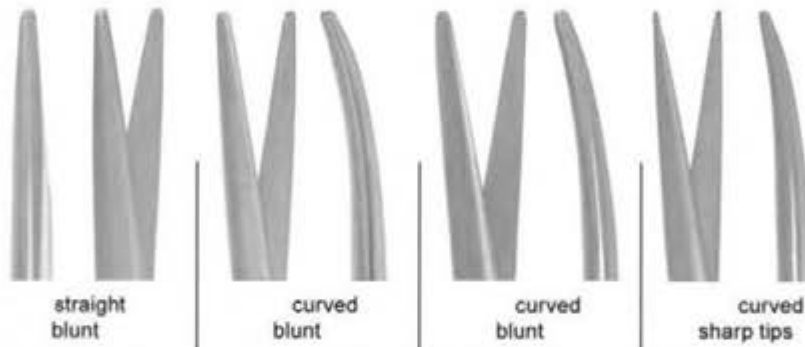

	straight blunt	curved blunt	curved blunt	curved sharp tips
145 mm, 5 3/4"	DSC 8280	DSC 8281		DSC 8313
180 mm, 7"	DSC 8282	DSC 8283		DSC 8315
200 mm, 8"			DSC 8285	

METZENBAUM-DELICATE





Daud Jee Mfg. Co



STAINLESS STEEL Scissors



	round tips	curved	curved
145 mm, 5 3/4"	DSC 8970		
180 mm, 7"		DSC 8273	
205 mm, 8"			DSC 8275

METZENBAUM FINO

	curved	straight
145 mm, 5 3/4"	DSC 8005	
180 mm, 7"	DSC 8007	DSC 8006
205 mm, 8"	DSC 8009	

METZENBAUM





Daud Jee Mfg. Co



Long STAINLESS STEEL Scissors

gebogen curved					
230 mm, 9"	DSC 8287				
255 mm, 10"		DSC 8297			
285 mm, 11 1/4"			DSC 8289		
305 mm, 12"				DSC 8291	

METZENBAUM FINO

	gebogen curved	gebogen curved	gerade straight		gebogen curved
230 mm, 9"	DSC 8011				
260 mm, 10"		DSC 8013			
285 mm, 11 1/4"		DSC 8015			
305 mm, 12"			DSC 8018	DSC 8017	

METZENBAUM





Daud Jee Mfg. Co



STAINLESS STEEL Dissecting Scissors



S-curved

180 mm, 7"	DSC 8057		DSC 8057-F
200 mm, 8"		DSC 8059	
285 mm, 9"		DSC 8061	DSC 8251

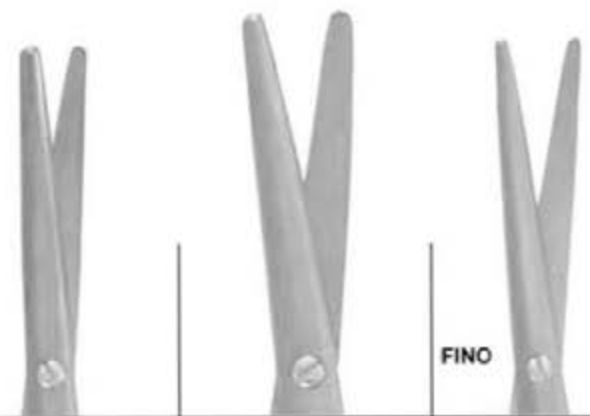

FINO

METZENBAUM-S

**Tunneling scissors
strongly curved**

fine, blunt
round tips

fine sharp
tips

180 mm, 7"	DSC 8107 (Fino)	DSC 8105 (Fino)
	DSC 8107-1 (Delikat)	DSC 8105-1 (Delikat)

HAJEK





Daud Jee Mfg. Co



STAINLESS STEEL Scissors



	straight	curved
150 mm, 6"	DSC 8096	
170 mm, 6 3/4"	DSC 8098	DSC 8999
200 mm, 8"		DSC 8930

MAYO-STILLE

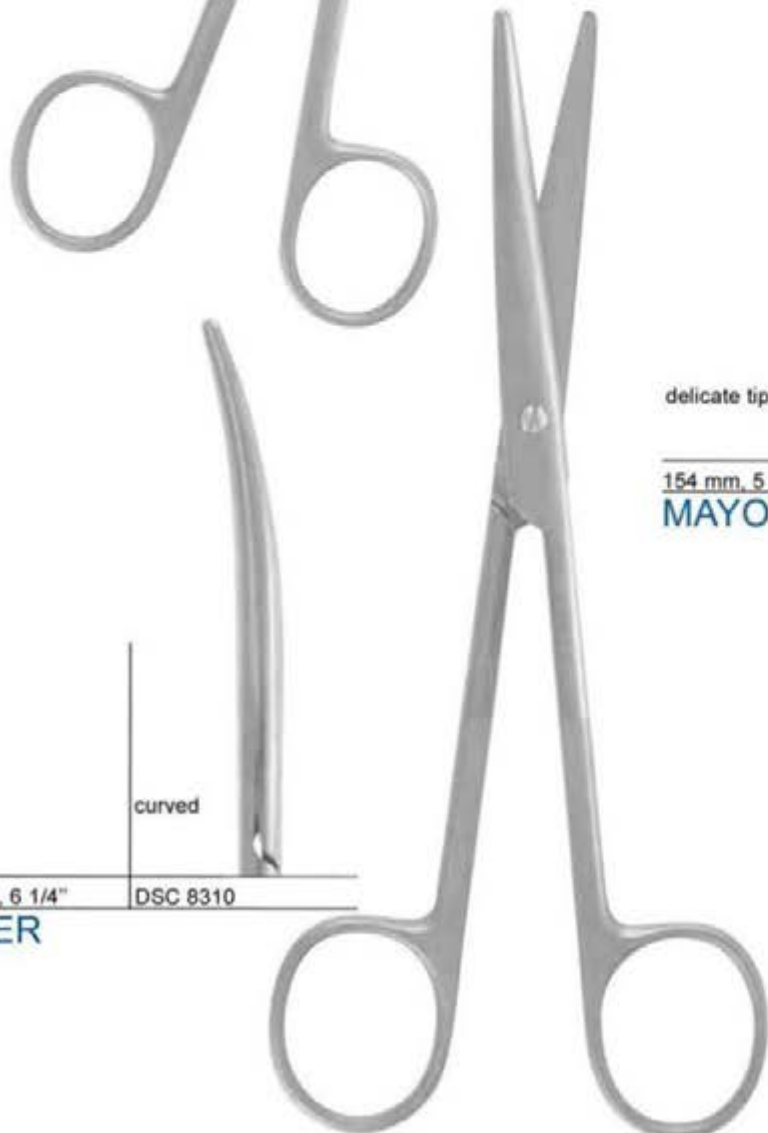

	delicate tips	curved
154 mm, 5 3/4"		DSC 8934

MAYO FINO



curved

DSC 8310

160 mm, 6 1/4"

LEXER



Daud Jee Mfg. Co



Strong STAINLESS STEEL Scissors



	straight	curved
145 mm, 6 3/4"		DSC 8913
170 mm, 6 3/4"	DSC 8910	DSC 8915
200 mm, 8"		DSC 8916
230 mm, 9"		DSC 8917
300 mm, 12"		DSC 8920

MAYO



	curved
200 mm, 8"	DSC 8370
230 mm, 9"	DSC 8371

SIMS



Daud Jee Mfg. Co



STAINLESS STEEL Scissors



sharp/blunt

blunt/blunt

145 mm, 5 3/4" gerade straight	DSC 8870	
170 mm, 6 3/4" gebogen curved	DSC 8451	DSC 8463

COOPER

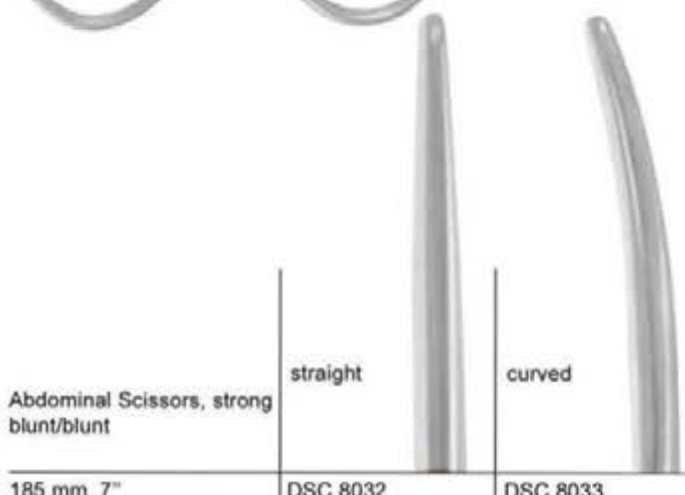

straight

curved

Abdominal Scissors, strong blunt/blunt

185 mm, 7"	DSC 8032	DSC 8033
------------	----------	----------

SIMS





Daud Jee Mfg. Co



STAINLESS STEEL Scissors

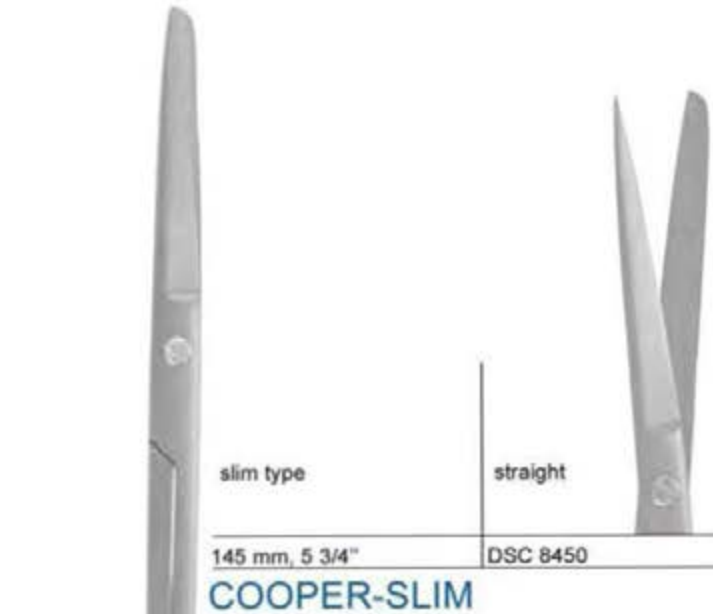

slim type

straight

145 mm, 5 3/4"

DSC 8450

COOPER-SLIM



115 mm, 4 1/4"

DSC 8130

EISELSBERG



170 mm, 6 3/4"

DSC 8750

SCHMIEDEN-TAYLOR

bandage scissor

200 mm, 8"

DSC 8225

LISTER





Daud Jee Mfg. Co



Vascular Clamps

Micro Mosquito delicate	anatomic straight	anatomic curved	surgical straight 1x2 teeth	surgical straight 1x2 teeth	anatomic straight	anatomic curved
100 mm, 4"	DKL 2296	DKL 2297	DKL 2224	DKL 2225		
120 mm, 4 3/4"	DKL 2202	DKL 2203	DKL 2204	DKL 2205	DKL 2208	DKL 2209
150 mm, 6"	DKL 2214	DKL 2215	DKL 2216	DKL 2217		DKL 2215K
150 mm, 6"		DKL 2233 Micro Delicate				

JACOBSEN

PYRAMID SERATED

Titanium Clamps angled 15°	24 mm straight	45° angled 24 mm	5 mm	9 mm	Titan Klemmen gerade Titanium Clamps straight	6 mm Löffelmaul Spoon Jaws
105 mm, 4"		DGFK 8019	DGFK 8020		105 mm, 4"	DGFK 8021
110 mm, 4 1/4"	DGFK 8018			DGFK 8022		

MICRO PEDRIATIC DE BAKEY

Titanium Clamps straight shanks	left angled	right angled
105 mm, 4"		
118 mm, 4 1/3"	DGFK 8091	DGFK 8092

MICRO KITZMILLER





Daud Jee Mfg. Co



Vascular Clamps



LAMBERT-KAY



	De Bakey	Cooley
200 mm, 8" Fig.1	DGF 1670	DGF 3000
250 mm, 10" Fig.2	DGF 1671	DGF 3010
250 mm, 10" Fig.3	DGF 1682	
280 mm, 10 1/4" Fig.4	DGF 1672	DGF 3020
285 mm, 10 1/2" Fig.5	DGF 1673	DGF 3030
270 mm, 10 3/4" Fig.6	DGF 1660	DGF 3040

SATINSKY





Daud Jee Mfg. Co



Delicate Clamps



90° angled	MICRO for Neonatal Aorta Diameter 8-10 mm	MICRO for Infants Aorta Diameter 14-16 mm	STANDARD for Teens Aorta Diameter 20-26 mm
150 mm, 6"	DKL 4051		
170 mm, 6 3/4"		DKL 4052	
180 mm, 7"			DKL 4053

AORTA DISECTING CLAMP



145 mm, 5 3/4"	DGF 2309	DGF 2311
----------------	----------	----------

CASTANEDA

115 mm, 4 1/2"	DKL 0102
181 mm, 7"	DKL 0101

BAILY MICRO

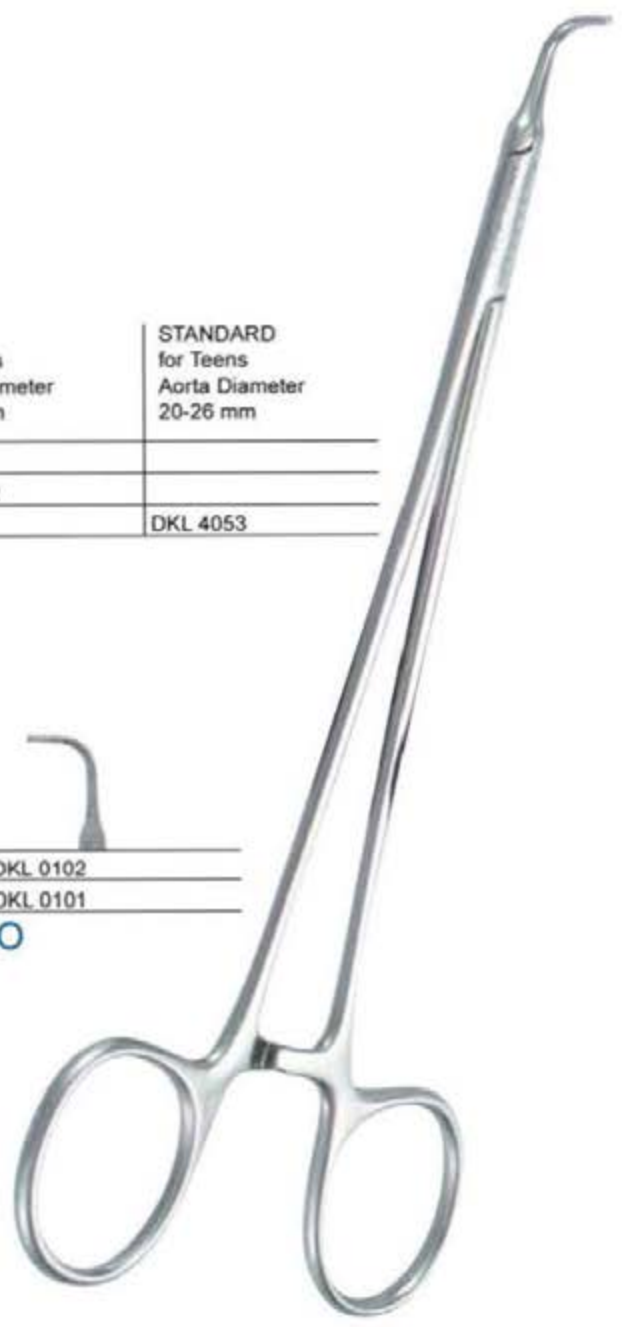



Daud Jee Mfg. Co



Delicate Clamps

COOLEY
Baby Vascular

125 mm, 5" DGF 2658

TEALDI



COOLEY

140 mm, 5 1/2" DGF 1052

CAROTIS
DELICATE



Baby Clamp

120mm, 5" DGF 1942

DE BAKEY-BABY





Daud Jee Mfg. Co









Micro-Bulldog Clamps



Bulldog clamps Pressure 30g	curved	curved	straight steel	straight
10 mm	DGF 0019	DGF 0019T	DGF 0022	DGF 0022T
15 mm	DGF 0020	DGF 0020T	DGF 0023	DGF 0023T
20 mm	DGF 0021	DGF 0021T	DGF 0024	DGF 0024T

SOFTGRIP MICRO 30g

					
strongly curved	45° angled	25° angled	90° angled	curved	straight
DGF 0651	DGF 0652	DGF 0653	DGF 0654	DGF 0655	DGF 0656

MINI-BULLDOGKLEMMEN



Daud Jee Mfg. Co



Micro-Cardio and Vascular Instrumente

Vascular Dilators	1,0 mm Kopf-Ø Head-Ø	1,5 mm Kopf-Ø Head-Ø	2,0 mm Kopf-Ø Head-Ø	2,5 mm Kopf-Ø Head-Ø	3,0 mm Kopf-Ø Head-Ø	3,5 mm Kopf-Ø Head-Ø	4,0 mm Kopf-Ø Head-Ø	4,5 mm Kopf-Ø Head-Ø	5,0 mm Kopf-Ø Head-Ø
140 mm 5 1/2"	DGF 0241	DGF 2042	DGF 0243	DGF 0244	DGF 0245	DGF 0246	DGF 0247	DGF 0248	DGF 0249

GARRET VASCULAR DILATORS

disector	stumpf blunt	scharf sharp
tip 1 mm	DGF 4901	DGF 4901

MICRO-DISSECTOR

Titanium handle	working length	MICRO 2 mm	3 mm
220 mm, 8 3/4" bajonett/ bajonette shape	95 mm	DGF 8905	DGF 8907
220 mm, 8 3/4" bajonett/ bajonette shape	115 mm		DGF 8908
220 mm, 8 3/4" gerade/ straight	115 mm		DGF 8900

DISSECTOR





Daud Jee Mfg. Co



Markierungsprodukte, Chirurgische Einmalprodukte Color Coded System, Single Use Products

Latexfrei
Latex free



Vasco-Loops reduzieren Verletzungen an den Gefäßen bei Occlusionen, besonders da wo eine blutstillende Klemme eingesetzt wird. Die fadenähnlichen atraumatischen Vertiefungen erlauben sanfte, konstante und rutschfeste Spannung.

- medizinisches Silikon
- drei Farben
- zwei 5" Längen pro steriler Beutel
- Röntgenfähig
- Auch un-steril erhältlich
- latexfrei

Vasco-Loops reduce trauma to vessels requiring occlusion, particularly where a hemostatic clamp is employed. The tread-like indents allow for gentle, constant, and non-slip tension.

- Medical-grade silicone
- Three colors
- Two 5" lengths per sterile pouch
- Radiopaque
- Also available non-sterile
- Latex free

Maße Dimensions

- 4 x 127 mm, 1/10" x 5"
- 7 x 127 mm, 2/10" x 5"
- 9 x 127 mm, 9 x 3 / 10" x 5"

Farbe Color

- red
- white
- blue

Artikelnr. Productno.

- DDSP 020
- DDSP 021
- DDSP 022

CLAMP JAW COVERS



Der Identifikation Tape ist in zehn Farben und zwei Größen (1/4" und 1/8") erhältlich. Hält wiederholtem Sterilisieren stand.

The Identification Tape is available in ten colors in 1/4" and 1/8" widths. Withstands repeated exposure to sterilization.

Farbe Color

- white
- blue
- green
- red
- yellow
- purple
- orange
- brown
- black
- orange / red

Breite 3 mm, width 1/8" Artikelnr. Productno.

- DDSP 070
- DDSP 071
- DDSP 072
- DDSP 073
- DDSP 074
- DDSP 075
- DDSP 076
- DDSP 077
- DDSP 078
- DDSP 079

Breite 6 mm, width 1/4" Artikelnr. Productno.

- DDSP 080
- DDSP 081
- DDSP 082
- DDSP 083
- DDSP 084
- DDSP 085
- DDSP 086
- DDSP 087
- DDSP 088
- DDSP 089

IDENTIFICATION TAPE



Daud Jee Mfg. Co

Index Artikelbeschreibung Index Item Description

ANATOMIC Micro Tissue Pliers	18	IDENTIFICATION TAPE	67	Needleless Scissors	31
Aorta Dissecting Klammern	49	Instrumentenschutzhüllen	55	PAFF Nutritional/vascular	52
Aorta Gefäßklammer	47	IRIS Augenschere Titan	33	PEACOCK Micro Scissors	28
ASANUS (Micro) SAFETY KNIFE	53	JAMESON Webster Titan Schere	25	PEN Micro Needleholder	10
ASANUS DE BAKKY COMBI Skalpellinstrument	20	JACOBS Gefäßklemme	46	PLASTIC Tissue Scissors	34
ASAN METZENBAUM MINI (Fing. schere, Titan)	17	JOSEPH Tissue Scissors	34	Plastische Scheren	27, 29 - 30
ASAN COMBI-SPEC. Mikro Kröpf- u. Nutzp., Titan	37	KANERD CASTROVIEJO Mikro Needleholder, Titan	9	PLATEAU Mikro Skalpellinstrument	21
ASAN, TOENNE-ADSON Präp. scheren, Titan	37	KILNER Polyparschere, Titan	35	PLATEAU Mikro Tissue Pliers	16
Astromatische Gefäßklammer	47 - 49	KILNER Supercut Schere	29	Potts Micro Scissors	24 - 27
BAILY MICRO Ligaturklemme	48	KOMBI-Mikro Stahlneedleholder	13	POTTS TITANIUM Scheren	26, 27, 30, 31
BAJO, Mikro Needleholder Titan	9	Kräftige Titan Scheren	42 - 44	POTTS SMITH Gefäßschere, Titan	31
Baynnett abgebogene Schere	26	LAMBERT-KAY Gefäßklemme	47	POWER CUT Brillant Schere	32
Baynnett Titan Pliers	19	LEDER Titan Präp.arschere	48	PYRAMID Gefäßklemme	46
Bauschleischschere, Titan	44	Ligaturklemme	42	RAGNELL-TULLA Präp.arschere, Titan	35
BOVN Augenschere Titan	33	LILLYNEE-POTTS Präp.arschere, Titan	37	Recall Schere	32
Buldhaken	50	LONG Tissue Pliers	19	REYNOLDS Titan Schere	35
CARDIO HOOK Gefäßinstrument	52	LISTER Verbandstoffschere TITANIUM	40	Ringspaltbarer Stahl und Titan	23
CARDIUS DELICATE Gefäßklemme	49	MASTER LIGHT Pliers	22	RINGTOP Mikro Stahl Pliers	16
CASIANUS Gefäßklemme	48	MARS Titan Präp.arschere	42	SALZBURG Titan Pliers	25 - 36
Castroviejo Mikro Stahl Needleholder	14	MICRO STILLE Titan Schere	42	SATOVSKY Gefäßklemme	47
Charcotier Titan Pliers	19	MC Inoue Mikro Tissue Pliers	19	Scheren	24 - 40
CLAMP JAW COVERS	57	METZENBAUM DELICATE Präp.arschere, Titan	38	SCHWEDEN TAYLOR Titan Schere	40
COOPER SLIM LINE, Titan Scheren	45	METZENBAUM FINE Präp.arschere, Titan	39 - 41	SIMS Präp.arschere	42
COOPER Titan Schere	44	METZENBAUM Präp.arschere, Titan	37 - 41	SUN LINE POTTS Schere, Titan	30
DE BAKKY Mikro Stahl Pliers	21	MICRO KITZMILLER Gefäßklemme	46	SUN LINE SWAN Mikro Schere	24 - 27
DE BAKKY Mikro Tissue Pliers	16	MICRO PEDRATIC DE BAKKY Gefäßklemme	46	SMOOTH Kröpfinstrument, Titan	17
DE BAKKY BABY Gefäßklemme	49	MICRO SLIM LINE POTTS Schere, TITANIUM	40	SOFTGRIP MICRO 30 g, Mikro Buldhohl.	50
DE BAKKY Titan Pliers	27 - 29	MICRO Stahlneedleholder	11 - 19	Stetho-Box	53
Diagnostischer Divertor	51	MICRO SWAN Mikro Schere	24 - 27	STEVENS Präp.arschere, Titan	33
Diagnostische Schere	55 - 57	MICRO-CARDIO Stahlneedleholder	12	STEVENS Titan Schere	36
EISELBERG Titan Schere	45	MICRO-DELICATE Stahlneedleholder	11	STRATTE Skalpellinstrument	15
ELEGANCE Mikro Needleholder, Titan	9	MICRO-TITAN Ringneedleholder	15	SUTURE CLAMP TAGS	54
ELEGANCE Skalpellinstrument	15	Microscope Dissector	53	SUTURE ORGANIZER	56
ELEGANCE SURE GRIP Mikro Tissue Pliers	17	Mikro Dissector	51	TALDH Kindergefäßklemme	49
ERGONOMY Mikro Stahlneedleholder	13	Mikro Fingerringe, Titan	17	TIGER Fingerschere, Titan und Stahl	10, 12
Fine Schere, Titan	33 - 38	Mikro Fischgriff Stahlneedleholder	13 - 14	TITANIUM Mikro Potts Scheren	26 - 27
GARRET Gefäß Klammern	51	Mikro Fischgriffschere	14, 26, 28	TITAN Schere	30 - 48
Gefäßschere, Titan	47 - 49	Mikro Kröpf- und Nutzpliers, Titan	17	TOENNE-ADSON Präp.arschere, Titan	37
GERALD Mikro Stahl Pliers	20	Mikro Needleholder, Titan	6 - 10	TOPAS Mikro Stahlneedleholder	14
GERALD Mikro Tissue Pliers	18	Mikro Pliers Titan	16 - 19	TWAS	54
GLASGOW Mikro Schere	29	Mikro Rundgriffschere	25, 31, 27	TUBE ORGANIZER	54
GOLF Needleless Scissors	31	Mikro Rundgriff Stahlneedleholder	11 - 12	VACU LOOPS	56
HAER Tunnel- und Präp.arschere, Titan	41	Mikro Stahl Pliers	20 - 21	Vascular clamps	47 - 49
HEPARIN Kanüle	53	Mikro Stahl Schere	24, 25, 28 - 30	Vascular forceps, Titanium	22 - 23
I.M.A. Epilektors	53	MINI Buldhaken	50	WARE, mikro Titan ring Pliers	18
		MICRO DELICATE Kröpfpliers, Titan	16		

DEUTSCH

abdominal strong scissors, Titan	44	IRIS eye scissors, Titan	33	FEN micro needle holder	10
ANATOMIC Micro Pliers, Skandinavien	18	JAMESON Webster Titan scissors	25	flexible surgery Titan scissors	29, 33 - 36
Aorta Gefäßklammer	47	JACOBS vascular clamps	46	PLASTIC Tissue scissors	34
ASANUS (Micro) SAFETY KNIFE	53	JOSEPH Titan scissors	34	PLATEAU micro steel forceps	21
ASANUS DE BAKKY COMBI Scalpels	20	KANERD Castroviejo micro needle hold., Titan	9	PLATEAU micro titanium forceps	16
ASAN METZENBAUM MINI dissect. scis., Titan	17	KILNER Supercut scissors	29	POTTS micro scissors	24 - 27
ASAN COMBI-SPEC. mik. Fing. and Nut. Pliers, Titan	37	KOMBI-micro steel needleholder	13	POTTS scissors, Titan	26, 27, 30, 31
ASAN, TOENNE-ADSON dissect. scis., Titan	37	LAMBERT-KAY vascular aortic clamps	47	POTTS SMITH vascular Titan scissors	31
Astromatische Gefäßklammer	47 - 49	LEDER Titan scissors	48	POWER CUT Brilliant Clamps	32
BAILY MICRO ligature clamps	48	Ligaturforceps	42	PYRAMID vascular Clamps	46
BAJO, micro needle holder, titanium	9	LILLYNEE-POTTS dissecting scissors, Titan	37	RAGNELL-TULLA dissecting Titan scissors	35
Baynnett shaped scissors	26	LONG titanium forceps	19	Recall scissors	32
Baynnett eye scissors, Titan	19	LISTER Titanium forceps	40	REYNOLDS Titan scissors	36
Bauschleischschere	44	MASTER LIGHT titanium forceps	22	ring needleholder steel and titanium	25
Buldhaken	50	MARS Titan dissecting scissors	42	RINGTOP micro steel forceps	16
CARDIO HOOK vascular instrument	52	MICRO STILLE Titan dissecting scissors	42	RINGTOP micro titanium forceps	16
CARDIUS DELICATE vascular clamp	49	MC Inoue micro titanium forceps	19	SALZBURG Titan Pliers	25 - 36
CASIANUS vascular clamp	48	METZENBAUM DELICATE dissect. scis., Titan	38	SATOVSKY vascular clamps	47
Castroviejo Mikro Stahl Needleholder	14	METZENBAUM FINE dissecting scissors, Titan	39 - 41	SCHWEDEN TAYLOR Titan scissors	40
CLAMP JAW COVERS	57	METZENBAUM Präp.arschere, Titan	37 - 41	scissors	24 - 40
clamping instrument system	47 - 50	METZENBAUM G-dissecting scissors, Titan	41	scissors, delicate, Titan	32 - 38
color coded systems	57	MICRO-CARDIO ring needleholders	15	SIMS dissecting scissors	42
COOPER SLIM LINE, Titan scissors	45	MICRO DELICATE steel needleholders	11	SUN LINE POTTS scissors, Titan	30
COOPER Titan scissors	44	MICRO DELICATE tying forceps, titanium	19	SUN LINE SWAN micro scissors	24 - 27
DE BAKKY micro steel forceps	21	micro dissectors	51	SMOOTH tying forceps, titanium	17
DE BAKKY micro titanium forceps	16	micro flat-handle scissors	34, 26, 28	SOFTGRIP Micro 30 g micro holding clamps	50
DE BAKKY titanium forceps	27 - 29	micro flat-handle steel needleholders	13 - 14	Stethoscope Box	53
DE BAKKY BABY vascular clamp	49	micro forceps, steel	20 - 21	STEVENS dissecting scissors, Titan	33, 35
dental scissors	34	micro forceps, titanium	16 - 19	STRATTE steel ring needleholder	15
diamond knives	53	MICRO KITZMILLER vascular clamps	46	suturing instruments	52
divertors	51	MICRO PEDRATIC DE BAKKY vascular clamps	46	surgical disposables	56 - 57
EISELBERG Titan scissors	45	micro needleholders, titanium	6 - 10	surgical forceps, titanium	29
ELEGANCE micro needle holder, titanium	9	micro round-handle scissors	25, 27	SUTURE CLAMP TAGS	54
ELEGANCE steel ring needleholder	15	micro round-handle steel needleholders	11 - 12	SUTURE ORGANIZER	54
ELEGANCE SURE GRIP micro titanium forceps	17	micro scalars, steel	24, 25, 28, 30	TALDH pediatric vascular clamp	49
ERGONOMY micro steel needleholder	13	MICRO SLIM LINE POTTS scissors, Titan	30	TIGER micro force, needle hold., Titan, and steel	10, 12
ERGONOMY Micro Stahl Needleholder	13	MICRO steel needleholders	11 - 15	TITANIUM micro Potts scissors	26 - 27
GARRET Vascular Divertor	51	MICRO SWAN scissors	24 - 27	TITAN scissors	30 - 46
GERALD micro steel forceps	20	MICRO-TITAN ring needleholders	15	Titanium scissors, strong models	42 - 44
GERALD micro titanium forceps	18	micro titanium tying forceps	17	TOENNE-ADSON dissecting Titan scissors	37
GLASGOW micro scissors	29	micro tying- and suture forceps, titanium	17	TOPAS micro steel needleholders	14
GOLF Needleless scissors	31	micro scalars, titanium	17	TWAS	54
HAER tunneling and dissecting scissors	41	MINI Buldhaken	50	TUBE ORGANIZER	54
HEPARIN cannula	53	needleless scissors	31	VACU LOOPS	56
I.M.A. epileptor retractors	53	PAFF suture fixation hook	52	vascular clamps	47 - 49
identification tape	57	PEACOCK micro scissors	28	vascular forceps, titanium	22 - 23
instrument grips	55	pediatric vascular clamps	48 - 49	WARE, micro titanium ring Pliers	18

ENGLISH

ACHTUNG
Sämtliche chirurgische Instrumente dürfen ausschließlich im Verhältnis zur Bauart eingesetzt werden, z.B. dürfen feine Schere nur zum Schneiden von feinstem Gewebematerial eingesetzt werden. Scheren dürfen nicht zum Schneiden von harten Materialien, insbesondere Kalk, verwendet werden. Asanus übernimmt keine Gewährleistung für alle auftretenden Schäden durch unsachgemäße Handhabung der Instrumente.

ATTENTION
All surgical instruments may be used only in accordance with its purpose. For example delicate scissors may not be used to cut hard materials like calcium deposits or plaque etc., if a user is not sure for handling Asanus surgical instruments he has to ask Asanus for the correct usage. In case of wrong handling of the Asanus surgical products Asanus cannot take any warranty.



Daud Jee Mfg. Co



Daud Jee Mfg. Co

Tell:

Fax:

web site : www.daudjeemfg.com